

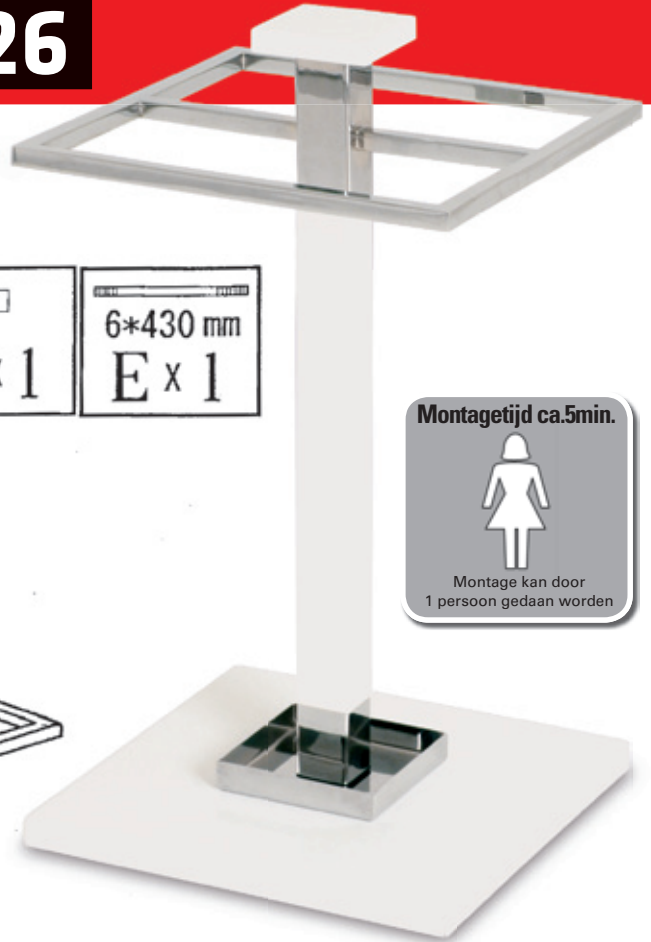







# Montagehandleiding 42326



 A x 1	 B x 2	 C x 1	 D x 1	 6*430 mm E x 1
--	--	--	--	--

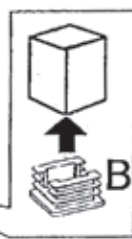
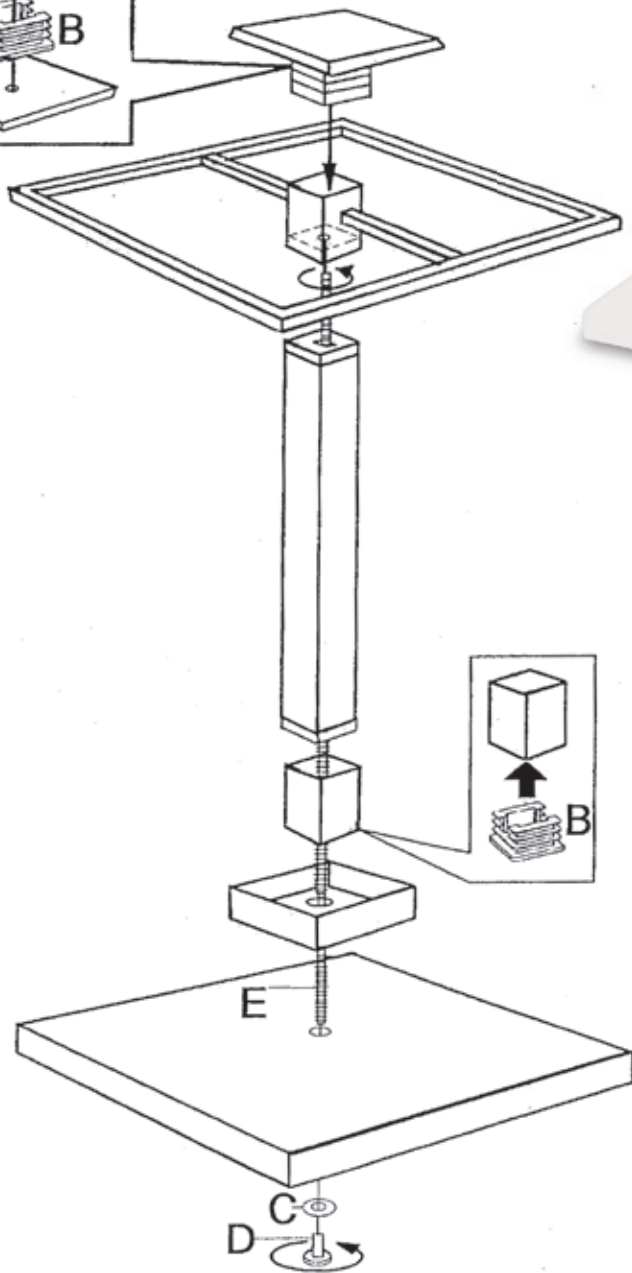
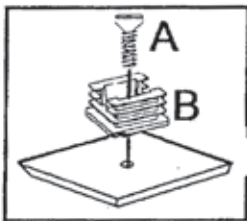

Montagetijd ca.5min.



Montage kan door  
1 persoon gedaan worden