

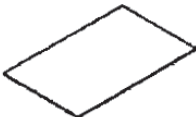



























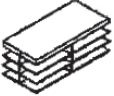

| | | | | | | | |
|---|--|--|--|---|--|---|---|
| A  1PC | B  1PC | C  1PC | D  2PCS | E  2PCS | F  2PCS | G  1PC | |
| H  2PCS | I  2PCS | J  1PC | K  1PC | L  2PCS | M  1PC | N  1PC | |
| 1  7PCS | 2  4PCS | 3  10PCS | 4  4PCS | 5  4PCS | 6  4PCS | 7  4PCS | |
| 8  6PCS | 9  12PCS | 10  2PCS | 11  3PCS | 12  2PCS | 13  4PCS | 14  1PC | 15  1PC |



1

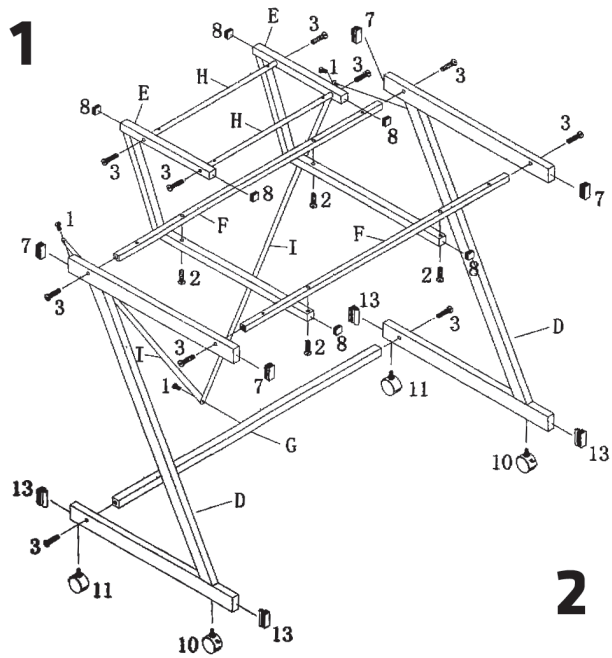

2

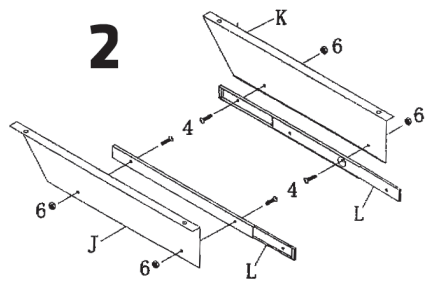

3

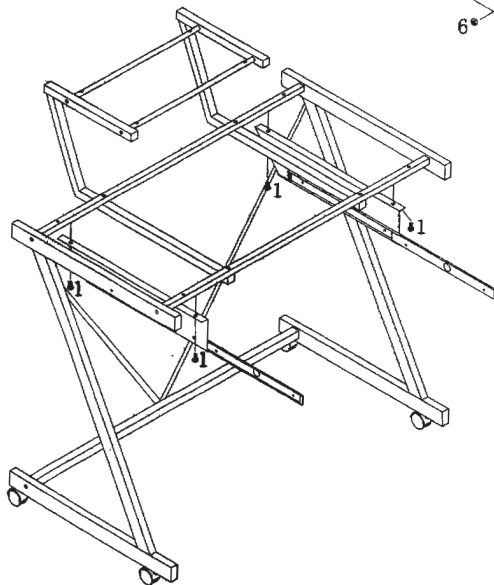

4

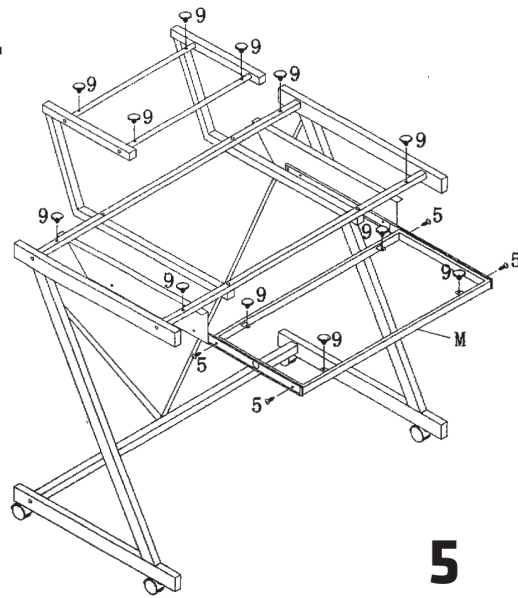

5

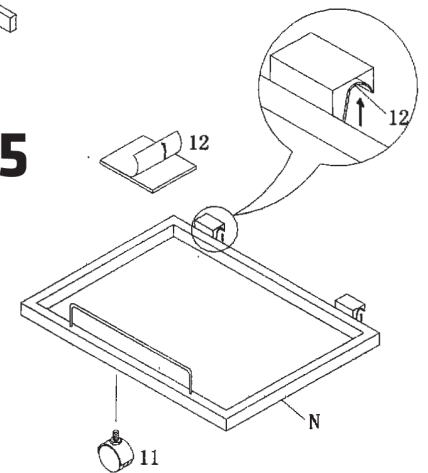

6

