

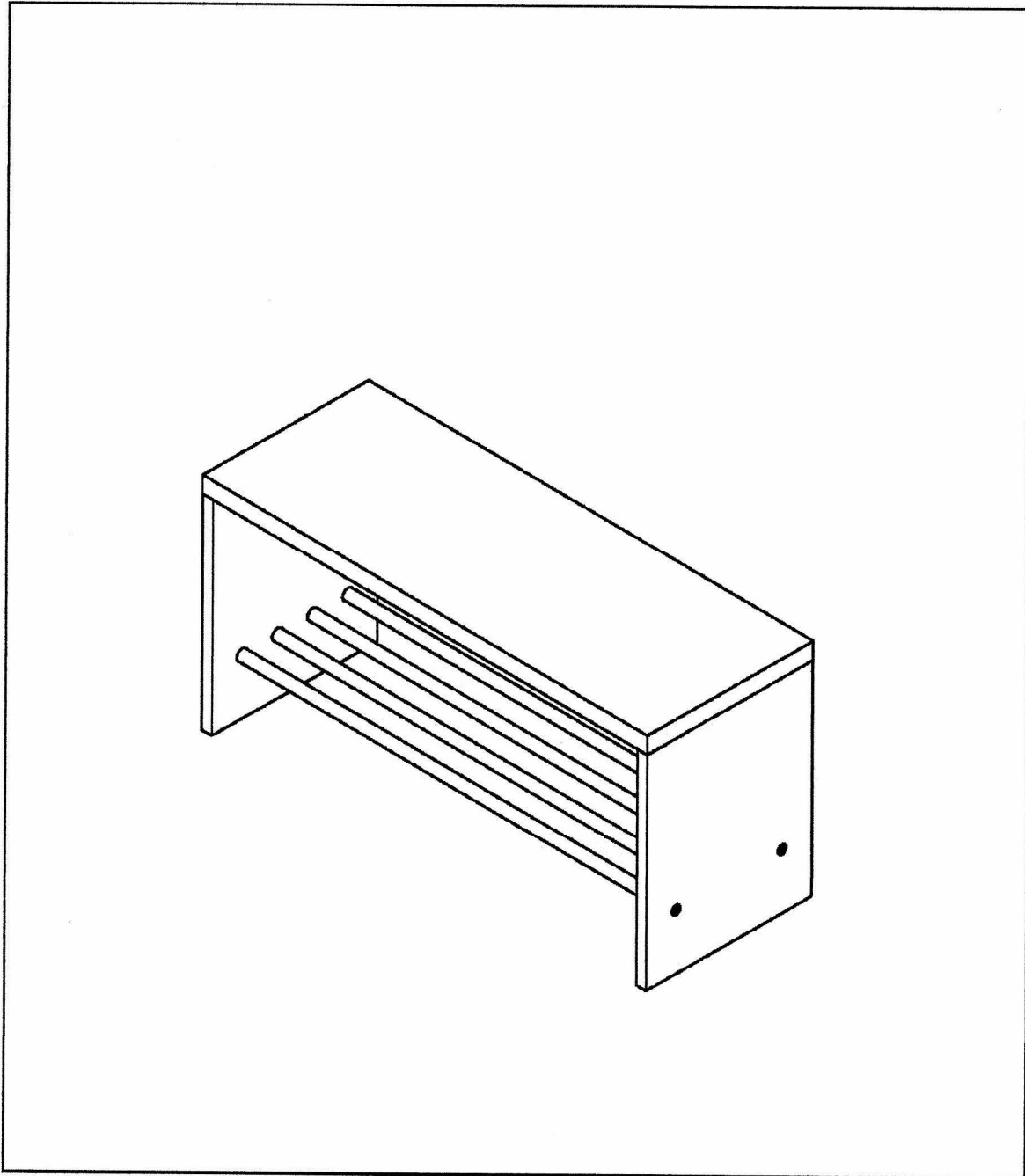













95530 (EK08008BW)



<p>A x 10</p>  <p>M6*35</p>	<p>B x 10</p>  <p>Ø15*12</p>	<p>C x 4</p>  <p>Ø7.8*30</p>	<p>D x 4</p>  <p>1/4**30</p>	<p>E x 1</p> 	<p>F x 10</p>  <p>Ø18*5</p>
<p>G x 4</p>  <p>Ø20</p>	<p>1</p>  <p>1</p>	<p>2</p>  <p>2</p>	<p>3</p>  <p>1</p>	<p>4</p>  <p>2</p>	<p>5</p>  <p>2</p>

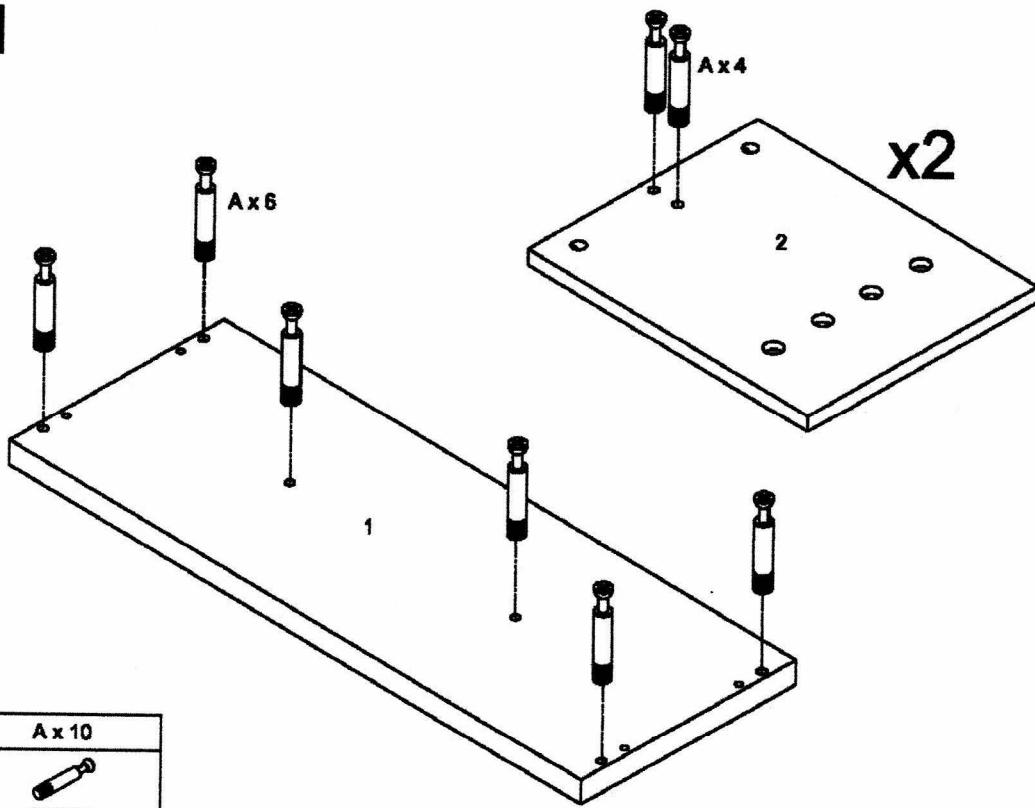





1

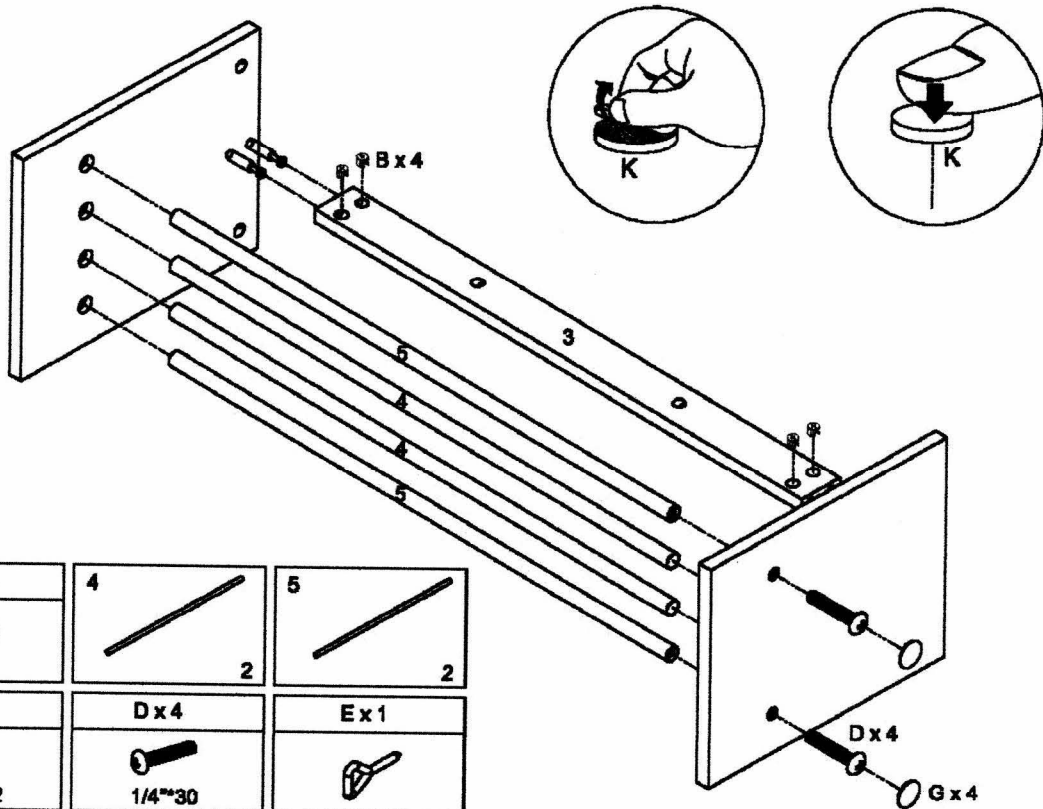

A x 10

M6*35



2

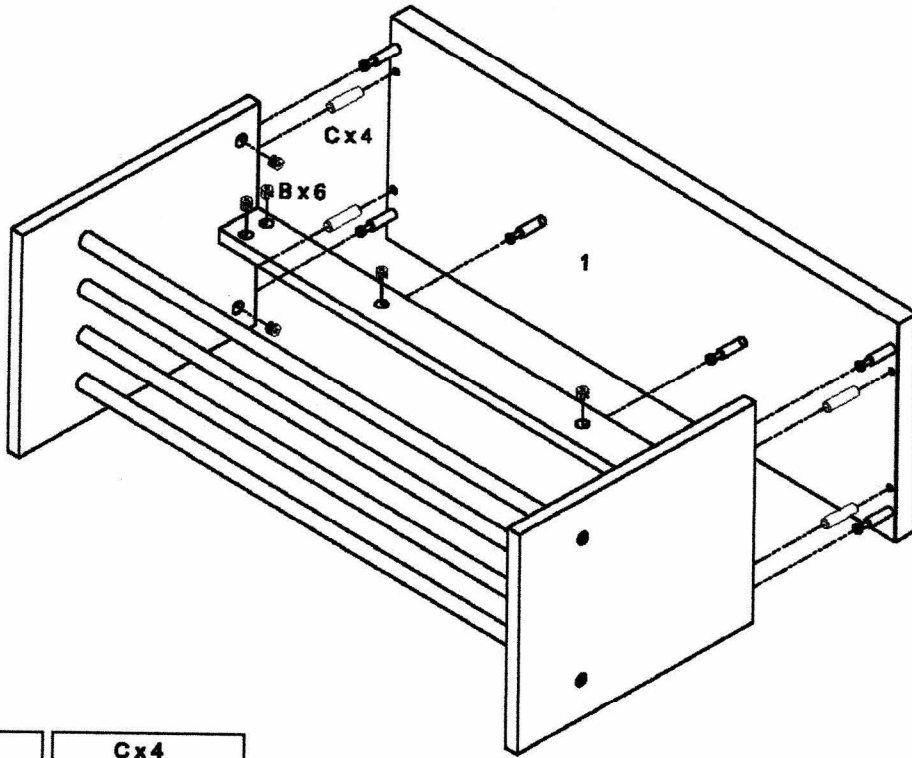

G x 4  Ø20	4  2	5  2
B x 4  Ø15*12	D x 4  1/4*30	E x 1 

3



B x 6	C x 4
	
Ø15*12	Ø7.8*30

4

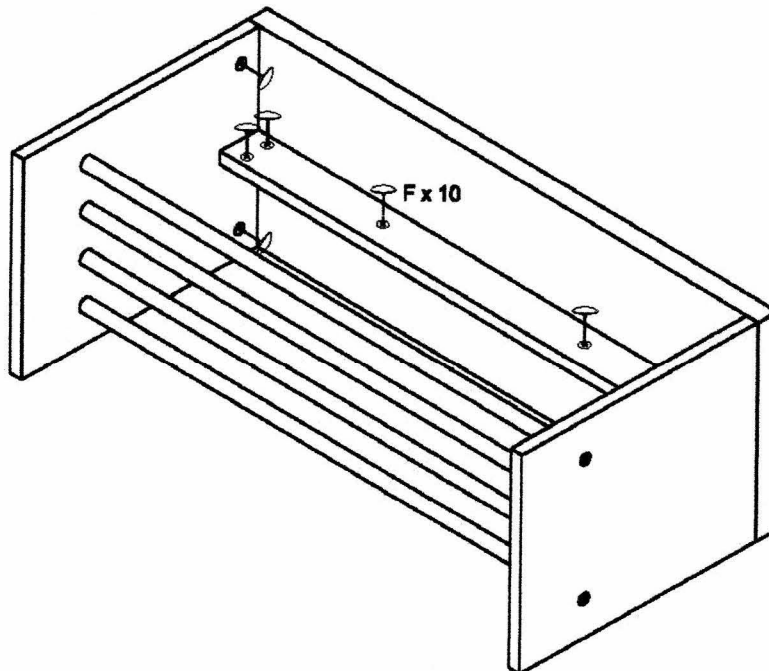

F x 10

Ø18*5