



Montagehandleiding





86792



Montagetijd ca.10min.

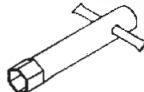
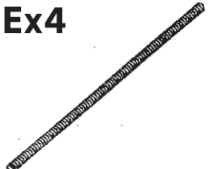

Montage kan door
1 persoon gedaan worden

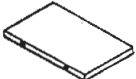
Ax4 	Bx4 	Cx4 	Dx1 
Ex4 	Fx4 	Gx1  590*294*40	Hx2  294*360*40

